

# Clean Fast

CF-980

by Top Innovations, Inc.

## CENTURION™

WATER FILTRATION VACUUM

*There's Vacuums.  
And then there's the Centurion.™*

- Water filtration technology traps dust and dirt, cleaning your floors and removing harmful allergens from the air you breathe
- Convenient bagless design is easy to use and environmentally friendly
- Variable suction control allows you to clean everything from delicate drapes and throw rugs to deep pile carpet
- Powerful 1200 watt motor makes even the biggest vacuuming task quick and simple



### TRIPLE STAGE AERO FILTRATION SYSTEM

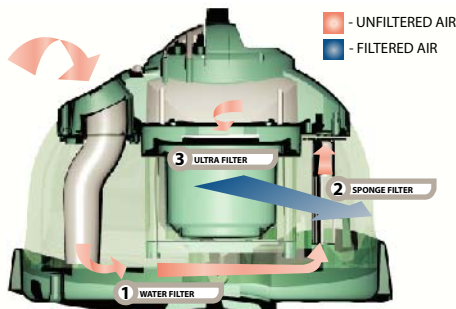

Triple stage filtration system works to catch microscopic particles and air impurities, such as dust, bacteria, and other allergens. By combining a Sponge Filter, a powerful ULTRA Filter, and ordinary tap water, the Centurion works not only to clean carpeted and hard surface floors, but the air as well.



# CENTURION™





## WATER FILTRATION VACUUM

*Clean  
Fast*

by Top Innovations, Inc.

### MODEL CF-980

## There's Vacuums. And then there's the Centurion.

-  **Water filtration technology traps dust and dirt, cleaning your floors and removing harmful allergens from the air you breathe**
-  **Convenient bagless design is easy to use and environmentally friendly**
-  **Variable suction control allows you to clean everything from delicate drapes and throw rugs to deep pile carpet**
-  **Powerful 1200 watt motor makes even the biggest vacuuming task quick and simple**

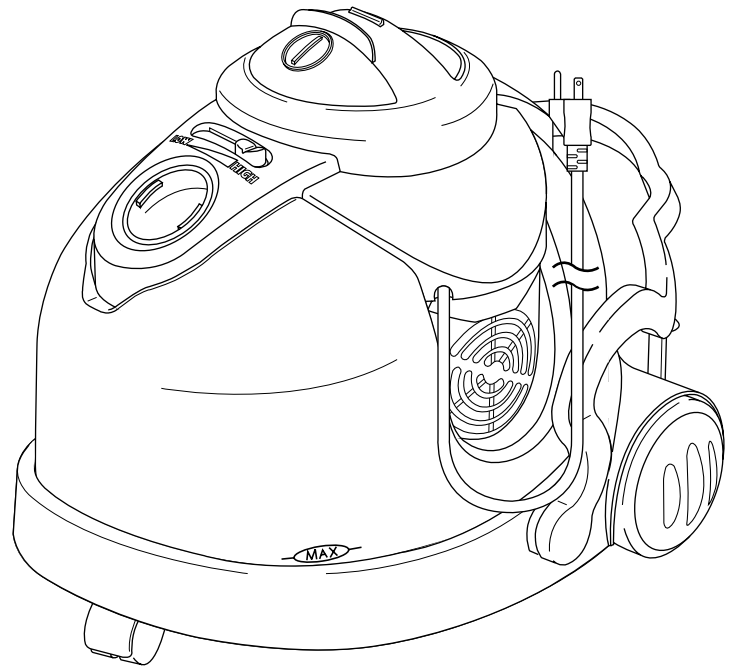

### ACCESSORIES INCLUDED:

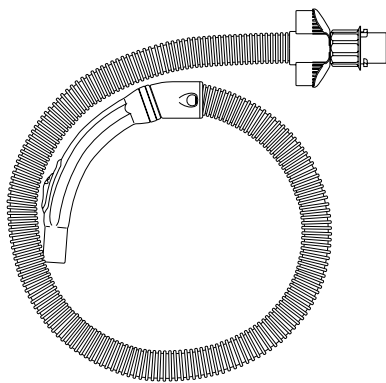

Flexible Hose

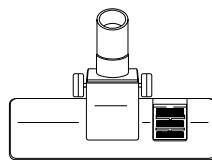

Floor Brush



ULTRA Filter



Telescopic Extension Tube



Crevice Tool



Upholstery Tool



MASTER CARTON	QUANTITY	UNIT INFO	MISCELLANEOUS
Units Per MC 1	20' Container 298 *	Unit Box Dim. (LxWxH) 19.75" x 16.75" x 16.13"	UPC# 0-47171-98000-7
Dimension (LxWxH) 19.75" x 16.75" x 16.13"	40' Container 643 *	Unit Box Weight 17.62 lbs	ITF# 100-47171-98000-4
Gross Weight 17.62 lbs	40' HQ Container 710 *	Unit Dim. (LxWxH) 17.38" x 15.50" x 15.13"	Unit Box is Drop Test Approved
Cube 3.09 cu. ft.	Pallet 16 *	Weight 14.76 lbs	